

**Graduate Student Life,
should it be my life?
A student's perspective.**

**Michael Lapsley
Ph. D. Candidate
11/15/2010**

PENNSSTATE



Department of Engineering Science and Mechanics

**B
i
o
m
e
d
i
c
a
l

N
E
M
S

L
a
b**

"Never regard your study as a duty."

~Albert Einstein

"Study hard what interests you the most in the most undisciplined, irreverent and original manner possible."

~Richard P. Feynman

"Being a graduate student is like becoming all of the Seven Dwarves. In the beginning you're Dopey and Bashful. In the middle, you are usually sick (Sneezy), tired (Sleepy), and irritable (Grumpy). But at the end, they call you Doc, and then you're Happy."

~Ronald T. Azuma

A PhD...

- Creates leaders.
- Is definitely NOT like being an undergraduate
- Is for dreamers, artists, and of course scientists
- Changes the way you think.
- Is for people who love to learn.
- Is one of the hardest and greatest transitions you will ever make!
- Is the START of your Scientific Career.

About me...

B
i

Husband



Father



Student

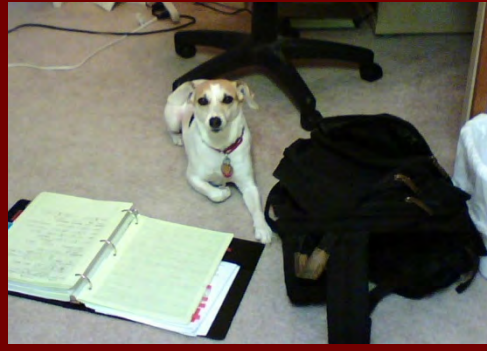

Teacher

Scientist

Research Engineer



PI

N
E
W
S
I
A
B

My Field: Microfluidics/Optofluidics

Lab-on-a-chip

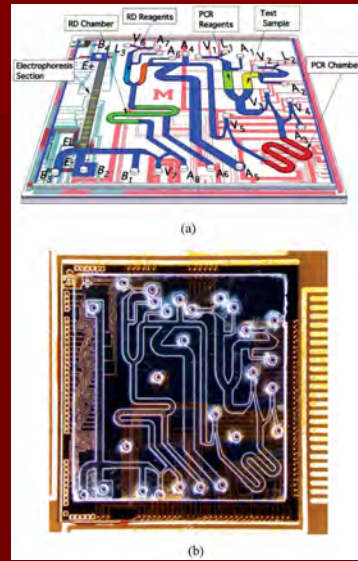
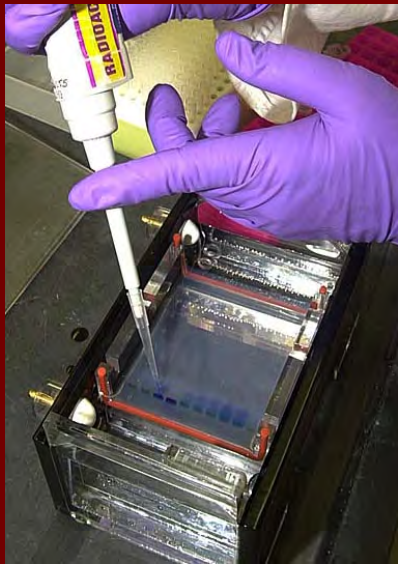

Simple Fabrication

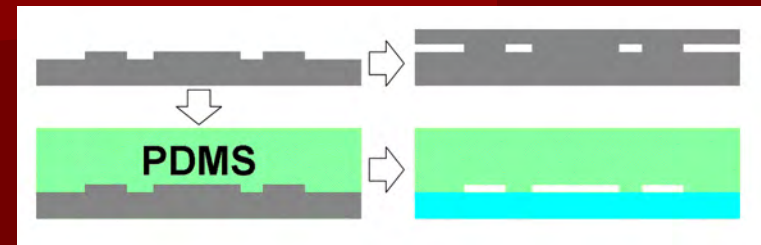

Flow Cytometry

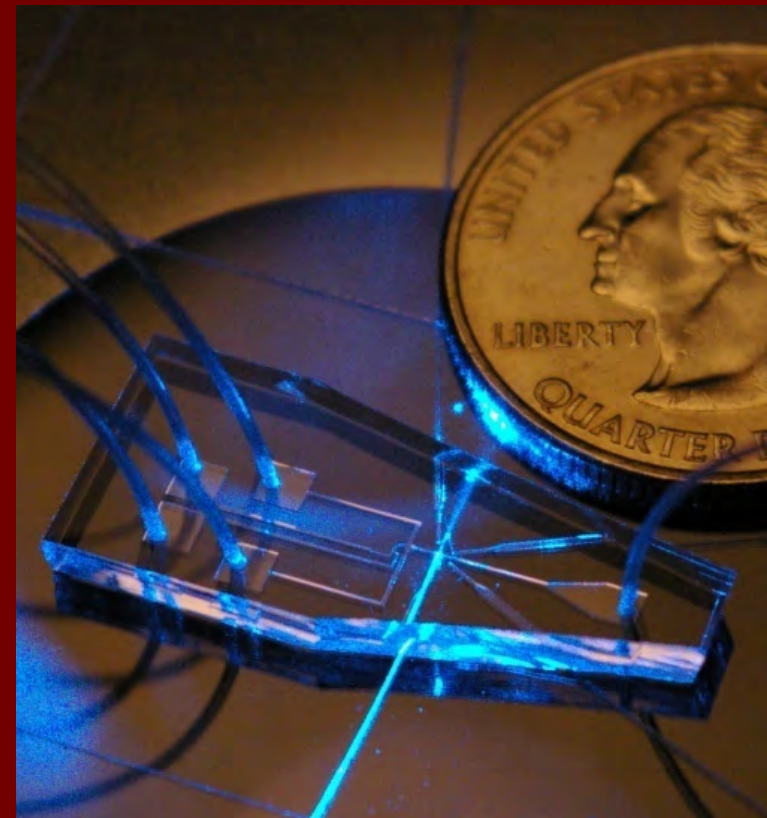

My work...

High Speed Bubble Mixer



Optical Attenuator

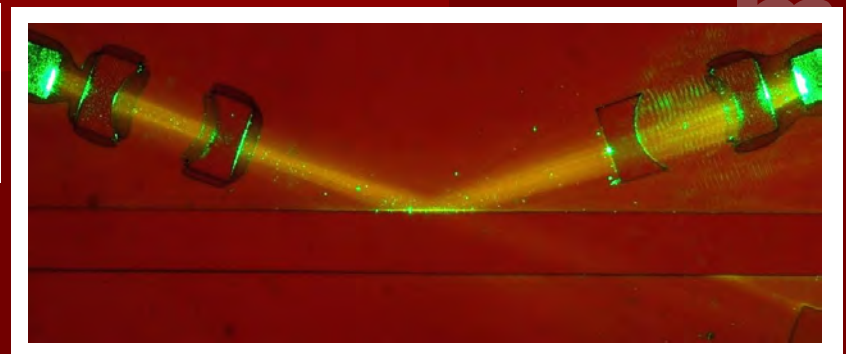

Tunable Liquid Lens

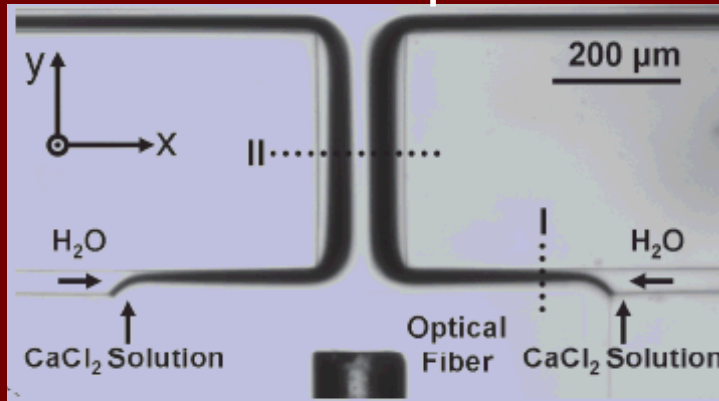

On-Chip Interferometer

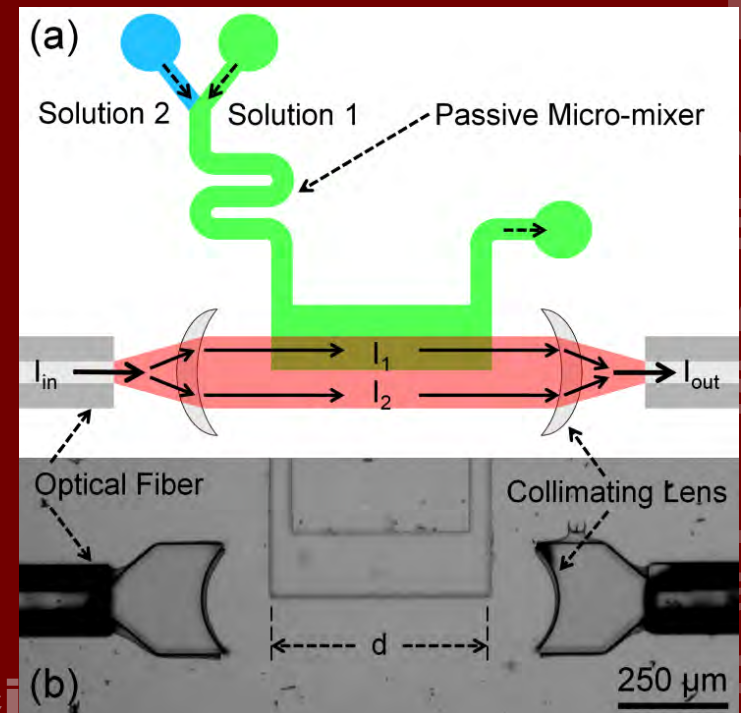

Where does a Ph. D. take you?

- University Professor
 - Research and teaching
 - Acquire government funding
 - Head research lab (freedom)
 - Work toward long-term and high impact research goals
- Research Scientist (Private Sector)
 - Acquire government funding
 - Head research programs (Management)
 - Design projects and experiments
- Research Scientist (Government)
 - Cutting Edge, High Budget
 - Teams of Ph. D.s
 - NASA
 - National Labs

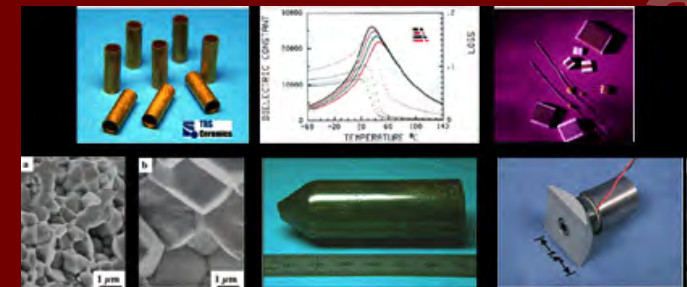

Masters of Science

- 1.5 – 2 years
- Many classes
 - More laid back than undergrad but harder material
 - Extend and advance undergrad understanding
- Get a taste for research
 - Find a research advisor
 - Work with a PhD student
 - See if you like the life
- Most people work as a TA
 - Research, Classes, Research, TA, Research, Sleep (maybe), Repeat...
- Time feels stretched

Ph. D.

- You must be 100% committed!
- 5-6 year (direct), 3-4 years after Master's
- You are more valuable and fitting for RA and likely to get fellowships.
- Classes (a few more than the Master's Requirement.)
- Apply the theory from your undergrad classes
- Develop skills in: organization, reporting, proposing, presenting, and running a project.
- Reading, Reading, Reading...
- Research, Research, Research...

Who goes to graduate School?

TABLE 2. First-time, full-time graduate enrollment in science, engineering, and health fields, by field and citizenship: 2006–08

Field	U.S. citizens and permanent residents					Temporary visa holders				
	2006	2007old ^a	2007new ^a	2008	% change	2006	2007old ^a	2007new ^a	2008	% change
					2007–08 ^a					2007–08 ^a
All survey fields	81,142	82,127	83,932	87,812	4.6	35,340	38,109	38,517	42,823	11.2
Science and engineering	60,978	62,009	64,284	68,093	5.9	33,435	36,196	36,706	40,726	11.0
Science	49,231	50,005	52,017	54,748	5.3	19,306	20,382	20,708	23,479	13.4
Engineering	11,747	12,004	12,267	13,345	8.8	14,129	15,814	15,998	17,247	7.8
Health	20,164	20,118	19,648	19,719	0.4	1,905	1,913	1,811	2,097	15.8

ne = not eligible; data were not collected for this field before 2007.

TABLE 4. Postdoctoral appointees in S&E fields, by sex, citizenship, and field, and in health fields: 1999–2008

Characteristic	1999	2000	2001	2002	2003	2004	2005	2006	2007old ^a	2007new ^a	2008	% change	
												1999–2008	2007–08 ^a
All survey fields	40,800	43,115	43,311	45,034	46,728	47,240	48,555	49,343	50,712	50,840	54,164	32.8	6.5
Science and engineering	28,980	30,224	30,196	31,937	33,666	34,065	34,456	34,887	35,894	36,223	38,203	31.8	5.5
Male	20,272	21,296	20,941	21,807	22,882	23,080	23,227	23,361	24,412	24,631	25,119	23.9	2.0
Female	8,708	8,928	9,255	10,130	10,784	10,985	11,229	11,526	11,482	11,592	13,084	50.3	12.9
U.S. citizens and permanent residents	12,725	12,627	12,073	13,524	13,542	13,969	14,078	14,111	14,903	15,107	16,274	27.9	7.7
Temporary visa holders	16,255	17,597	18,123	18,413	20,124	20,096	20,378	20,776	20,991	21,116	21,929	34.9	3.9

Money: Fellowships

- This is where you want to be.
- Eligibility
 - 49/130 Require U S Citizenship.
(<http://www.gradsch.psu.edu/current/funding/external/awardlist.cfm?filter=EN&order=d&detail=short&submit=Refresh>)
 - 14/17 Require U S Citizenship.
(http://www.epp.cmu.edu/graduate/fellow_index.html)
 - 26/48 Require US Citizenship
(https://engineering.purdue.edu/CE/Academics/Graduate/Future/Funding/COE_Fellowship_List_8-09.pdf)
- Small, supplemental (1,000-5,000)
 - Helps pay for books and other expenses
 - Still need another form of funding
- Large
 - Tuition
 - Stipend
 - Saves your advisor money, more money for the lab
 - Guarantee of funding for the duration
 - Prestigious and makes you valuable
 - You will be more likely to be accepted into the best professor's labs

Research Assistant

- Funded by your research advisor.
- Must prove yourself worthy
- Get paid to do what you love
 - Tuition
 - Stipend (typically more than a TA)
- Freedom to explore and create

Money: Teaching Assistant

- Some people love it
- Most people feel like this!

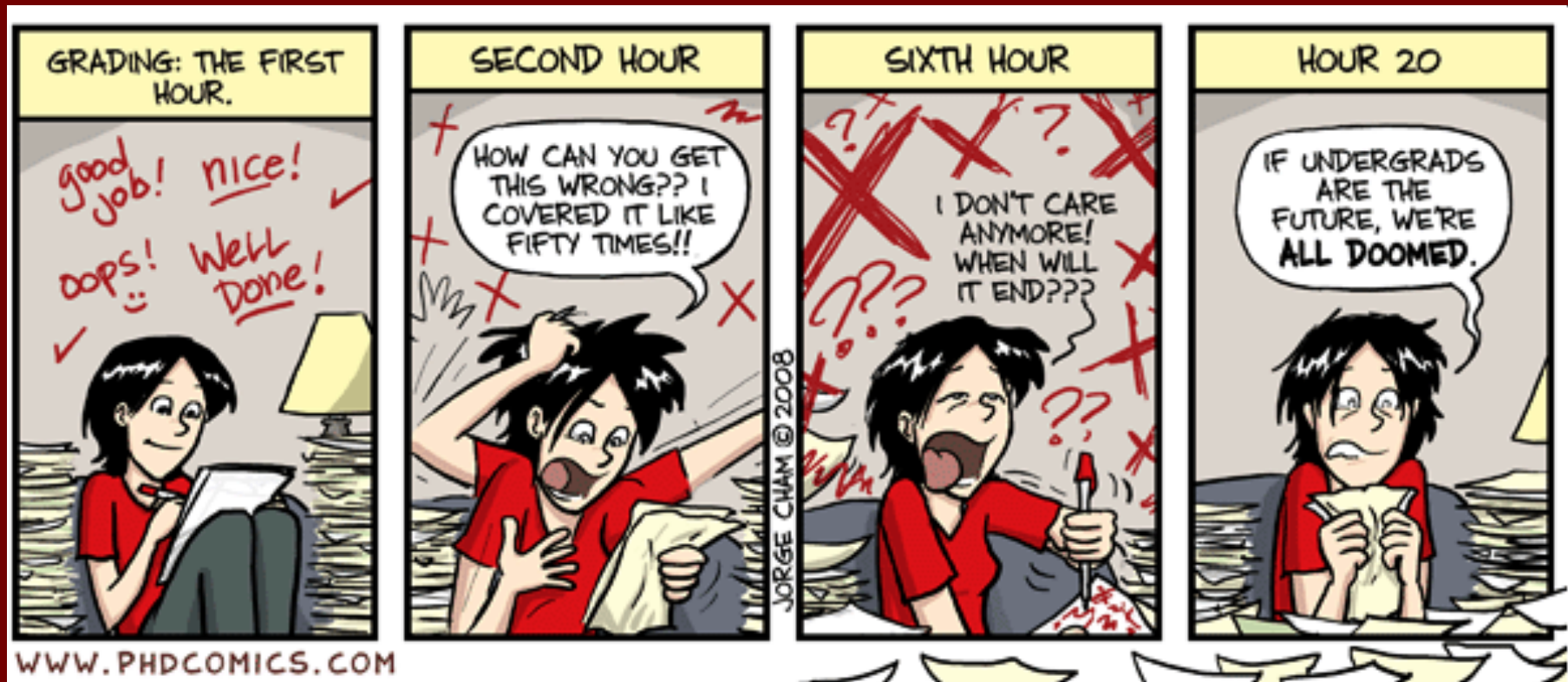

<http://www.phdcomics.com/comics/archive.php?comid=974>

PENNSTATE



Department of Engineering Science and Mechanics

B
i
o
m
e
m
o
r
y

Average Salary after Graduation



- Typically, a Ph. D. is not a fast track to wealth.
- This is a position for people who love research.

The "Toys"

B
i
o
m
e
d
i
c
a
l

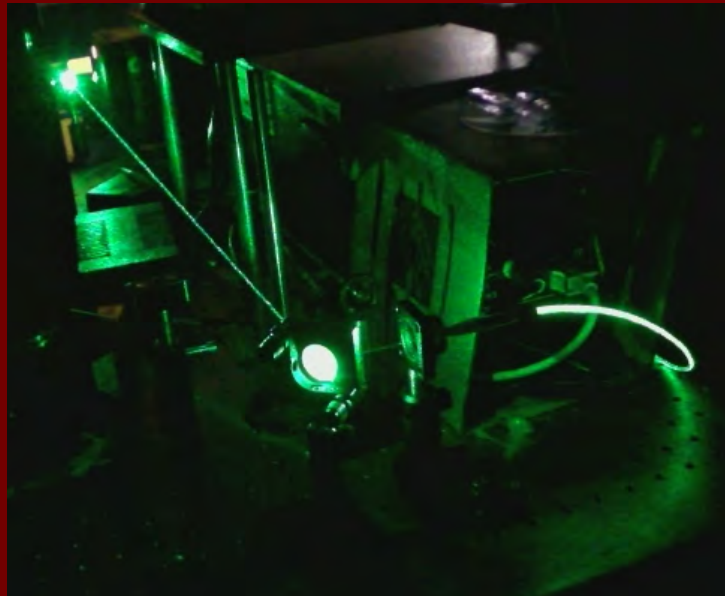
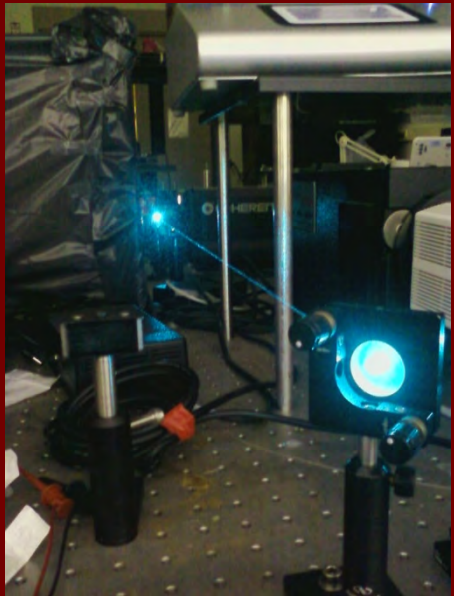
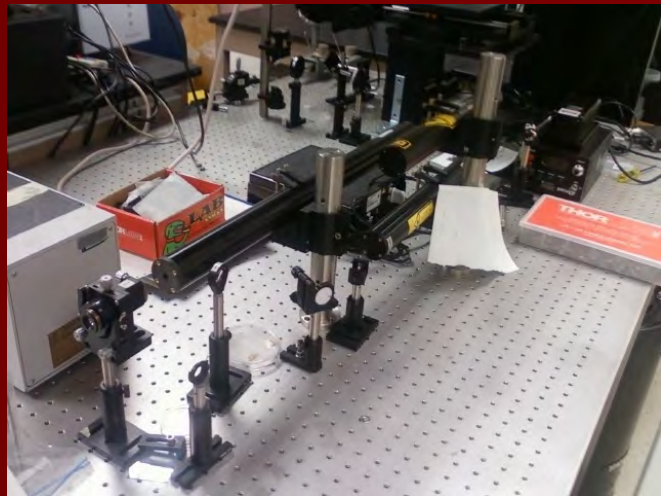

P

The Toys



Nanofabrication "Toys"

B
i



Testimonials

Xiaoyun Ding



■ Why did you come to graduate school?

- To pursuit my academic dream.
- I want to **explore the scientific mechanism** behind phenomenon
- or **develop some techniques to make life better.**
- Although the contribution may be minimum, even negligible, once there is any contribution, I would be more than happy.
- To find a better job with higher salary

■ What is your favorite part of graduate studies?

- To find something new and win respect from others.

■ What is your least favorite part of graduate studies?

- Not enough money.

■ Any other comments you have about graduate school in general.

- Make sure you like research before going to graduate school, once you enjoy research, instead of complain, you will feel full when you are doing experiment in the Lab **at the middle night or on weekends.**
- Going to graduate school not only **challenge your patience**, but also the capability of **management on multiprojects.**

PENNSTATE



Department of Engineering Science and Mechanics

B
i
o
m
e
d
i
c
a
l
N
E
M
S
L
a
b

Testimonials

Yanhui Zhao



- Why did you come to graduate school?
 - The desire to **become a knowledgeable person** in as many aspects as possible.
- What is your favorite part of graduate studies?
 - The training on **solving problems independently**
 - Thinking of a problem in different but through ways,
 - Respect others achievement and intelligence and **gain respect** from others,
 - **Express your idea effectively** and have the ability to convince other people,
 - Team work
- What is your least favorite part of graduate studies?
 - Concerned that he will be too specialized to find a good job.
- Any other comments you have about graduate school in general.
 - Although research is important for graduate study, **it is the way you are thinking and your insightful perspective** about this world that really matter in the end.

PENNSTATE



Department of Engineering Science and Mechanics

B
i
o
m
e
d
i
c
a
l
N
E
M
S
L
a
b

Testimonials



Daniel Ahmed

- **Why did you come to Graduate School?**
 - I always wanted to become a **professor**. Surprisingly, I am still on track to become a professor
- **What is your favorite part of graduate studies?**
 - To me grad students are **artists**.
 - In graduate school you will live hand to mouth. But grad students don't care, **they do what they love most in life, their research.**
 - **90% of the time you research will fail, but when you get something right, you will find the best feeling on earth.**
 - Basically you have the **freedom** to do anything you want.
- **What is your least favorite part of graduate studies?**
 - Too little money
 - The occasional complaining how miserable our lives are... **though we completely forget when we get some new results next day.**
- **Any other comments you have about graduate school in general?**
 - In general, **grad life is great**, you meet lots of awesome people, who really care about others.... and most likely they will become friends for the rest of your life.

PENNSTATE



Department of Engineering Science and Mechanics

B
i
o
m
e
d
i
c
a
l
E
N
G
I
N
E
E
R
I
N
G

Conclusion

- Graduate school is hard work, long hours, and will not necessarily make you rich. (or poor)
- It will test the levels of your patience with extreme frustration.
- It gives you great freedom and opportunity to bring your ideas to life.
- It will change the way you approach problems, giving you a new level of confidence.
- It will make you a leader.
- This *trial by fire* will make you an asset to any research team you join after graduation.
- Interested undergrads should START EARLY!
- Any Questions?
- My email: MIL112@PSU.EDU